

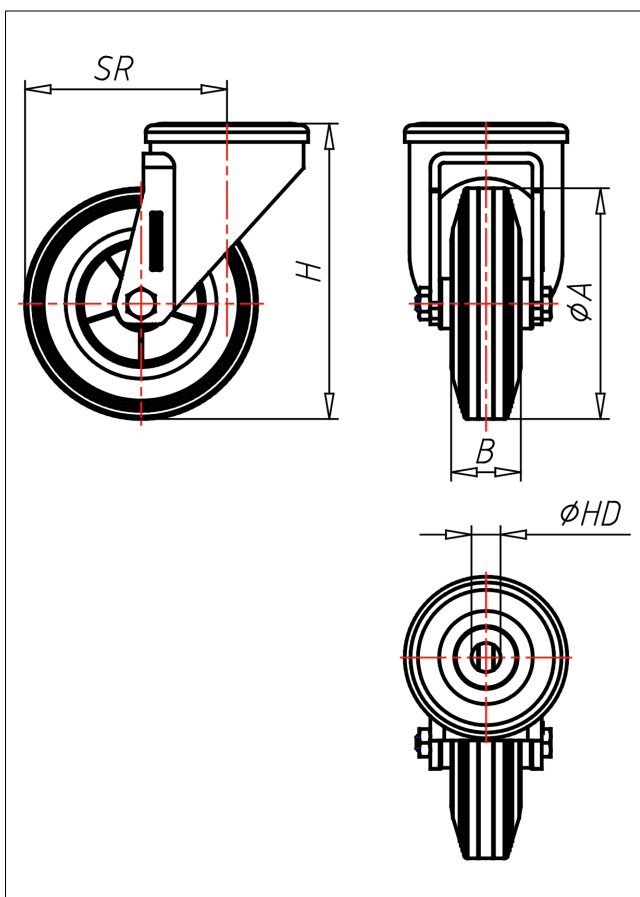

XR-DGBX/DG

Lenkrolle



XR-DG



LENKROLLE	LENKROLLE MIT TOTALFESTSTELLER																			
<ul style="list-style-type: none"> • spurfrei - bodenschonend • hoher Fahrkomfort • sehr lauffähig • geringer Rollwiderstand • abriebfest ELASTIK-Vollgummi Felge Kunststoff → Seite 202	zweifaches Kugellager - vernietet, Staubschutzring, Edelstahl AISI 304 poliert, Laufkugeln AISI 420, Radachse verschraubt → Seite	AUSWAHLHILFE: <table border="0"> <tr> <td>•</td><td>+</td><td>++</td> </tr> <tr> <td>leicht lenkend</td><td>X</td><td>●</td> </tr> <tr> <td>verschleißarm</td><td>●</td><td>●</td> </tr> <tr> <td>stoßfest</td><td>X</td><td>●</td> </tr> <tr> <td>bodenschonend</td><td>●</td><td>X</td> </tr> <tr> <td>witterungsbeständig</td><td>●</td><td>X</td> </tr> </table>	•	+	++	leicht lenkend	X	●	verschleißarm	●	●	stoßfest	X	●	bodenschonend	●	X	witterungsbeständig	●	X
•	+	++																		
leicht lenkend	X	●																		
verschleißarm	●	●																		
stoßfest	X	●																		
bodenschonend	●	X																		
witterungsbeständig	●	X																		

Technische Details

ORDERNO (Artikel-nummer)	XR 150 DG
WDAB (Rad-Ø A x Breite B / mm)	150x40
LC (Tragkraft / kg)	150
H (Bauhöhe H / mm)	181
HD (Loch-Ø / mm)	12.5
SR (Schwenkradius / mm)	126
WB (Radlager)	Polyamid-Gleitlager