

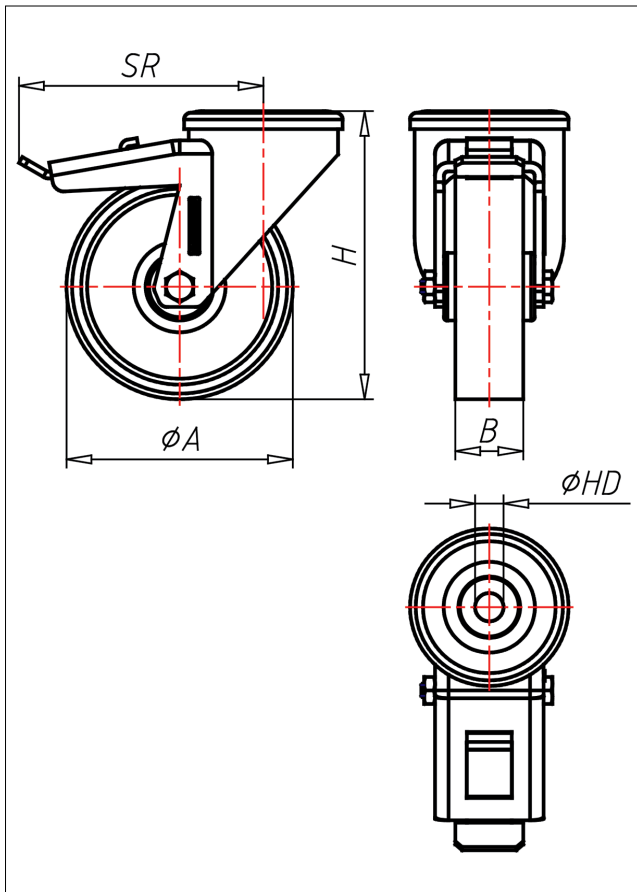

XRT/XRST-AL/ALBX

Lenkrolle mit Totalfeststeller



XR-AL



LENKROLLE	LENKROLLE MIT TOTALFESTSTELLER	
<ul style="list-style-type: none"> • geringer Rollwiderstand • abrieb- und reißfest • leichte Reinigung • sehr beständig gegen viele aggressive Medien Spritzguss-Polyurethan Felge Polyamid 6 → Seite 233	zweifaches Kugellager - vernietet, Staubschutzring, Edelstahl AISI 304 poliert, Laufkugeln AISI 420, Radachse verschraubt → Seite	AUSWAHLHILFE: leicht lenkend <input checked="" type="checkbox"/> <input type="checkbox"/> <input type="checkbox"/> verschleißarm <input type="checkbox"/> <input checked="" type="checkbox"/> <input type="checkbox"/> stoßfest <input type="checkbox"/> <input checked="" type="checkbox"/> <input type="checkbox"/> bodenschonend <input type="checkbox"/> <input checked="" type="checkbox"/> <input type="checkbox"/> witterungsbeständig <input type="checkbox"/> <input checked="" type="checkbox"/> <input type="checkbox"/>

Technische Details

ORDERNO (Artikel-nummer)	XRT 80 AL
WDAB (Rad-Ø A x Breite B / mm)	80x25
LC (Tragkraft / kg)	100
H (Bauhöhe H / mm)	106
HD (Loch-Ø / mm)	12.5
SR (Schwenkradius / mm)	108
WB (Radlager)	Polyamid-Gleitlager